



# **Interaction Design & Usability**



Design is not just how things look, it's about

# how they work

The screenshot shows the Craigslist website for New York City. The header includes the 'craigslist' logo, a 'post to classifieds' link, and a 'my account' link. Below this is a search bar with the text 'search craigslist' and a dropdown menu currently set to 'for sale'. An 'event calendar' is displayed as a grid with the date '23' highlighted. The main content area is divided into several columns of category links: 'community' (activities, artists, childcare, general, groups, pets, events), 'housing' (apts / housing, rooms / shared, sublets / temporary, housing wanted, housing swap, vacation rentals, parking / storage, office / commercial, real estate for sale), 'jobs' (accounting+finance, admin / office, arch / engineering, art / media / design, biotech / science, business / mgmt, customer service, education, food / bev / hosp, general labor, government, human resources, internet engineers, legal / paralegal, manufacturing, marketing / pr / ad, medical / health, nonprofit sector, real estate, retail / wholesale, sales / biz dev, salon / spa / fitness, security, skilled trade / craft, software / qa / dba, systems / network, technical support, transport, tv / film / video, web / info design, writing / editing, [ETC], [ part-time ]), 'personals' (strictly platonic, women seek women, women seeking men, men seeking women, men seeking men, misc romance, casual encounters, missed connections, rants and raves), 'discussion forums' (adopt, apple, arts, atheist, autos, beauty, bikes, celebs, comp, crafts, diet, divorce, dying, eco, educ, feedback, film, fitness, fixit, haiku, health, help, history, housing, jobs, jokes, kink, legal, linux, m4m, manners, marriage, media, money, motocy, music, nonprofit, open, philo, photo, p.o.c., politics, psych, queer, religion, romance, science, spirit, sports, tax, travel, tv, vegan, w4w, wed, wine), 'for sale' (antiques, baby+kid, barter, bikes, boats, books, business, computer, free, furniture, general, household, jewelry, materials, rvs+camp, sporting, tickets, tools, wanted, appliances, arts+crafts, atv/utv/sno, auto parts, beauty+hlt, cars+trucks, cds/dvd/vhs, cell phones, clothes+acc, collectibles, electronics, farm+garden, garage sale, heavy equip, motorcycles, music instr, photo+video, toys+games, video gaming), 'services' (beauty, creative, computer, cycle, event, financial, automotive, farm+garden, household, labor/move, skill'd trade, real estate), and 'nearby ci' (albany, allentown, baltimore, binghamton, catskills, central nj, delaware, eastern ct, harrisburg, hartford, hudson valley, jersey shore, lancaster, long island, new haven, new york, north jersey, northwest ct, oneonta, philadelphia, poconos, reading, rhode island, scranton, south coast, south jersey, western mass, williamsport, worcester, york). At the bottom of the 'nearby ci' list are links for 'us cities', 'us states', 'canada', and 'cl worldwide'.



If looks were everything, no one would have ever heard of Craigslist

# **1 Purpose**

What is this?

# **2 Orientation**

Where am I?

# **3 Intuition**

What do I do?



# PURPOSE

What is this? (Don't leave anyone guessing)

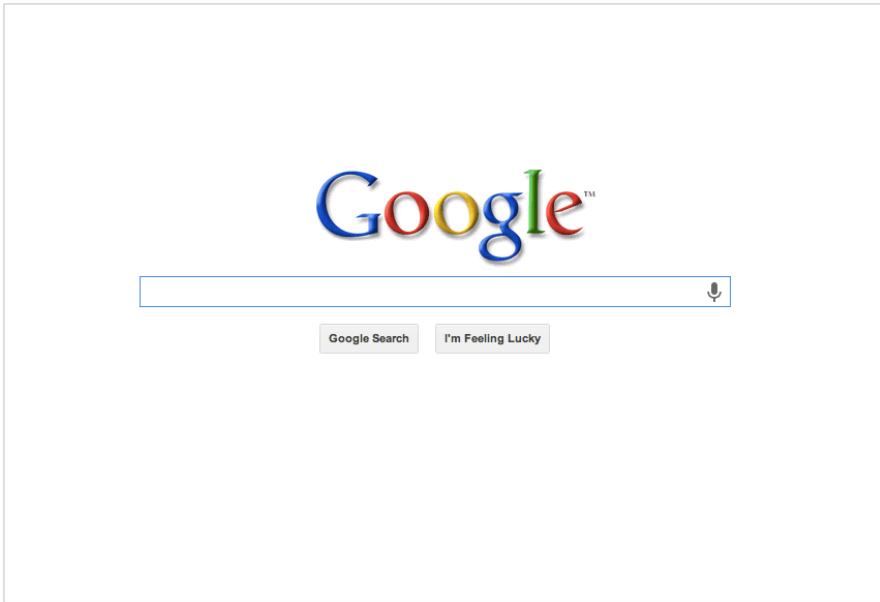

↑ Search!

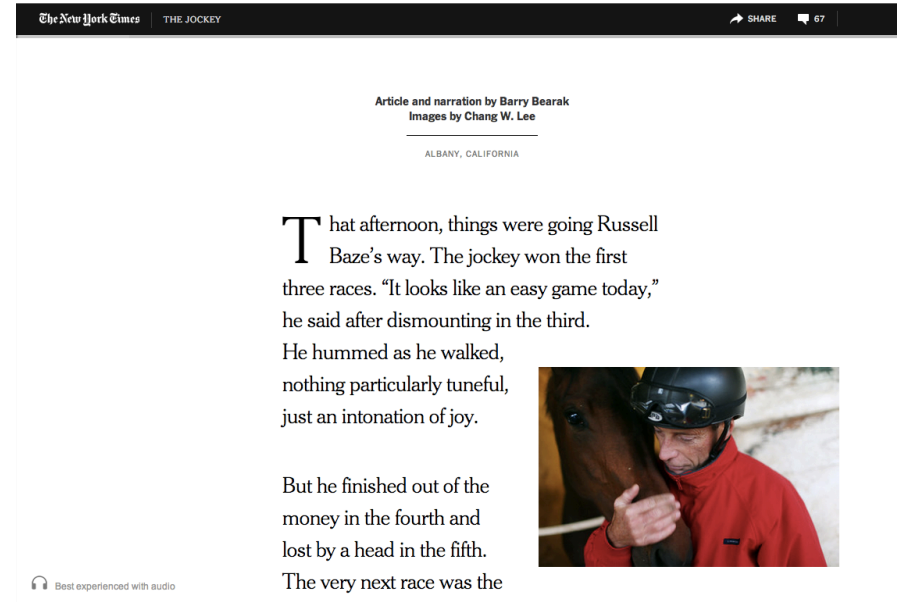

↑ Read a story!



*today's news*

↑ Fashion stuff!

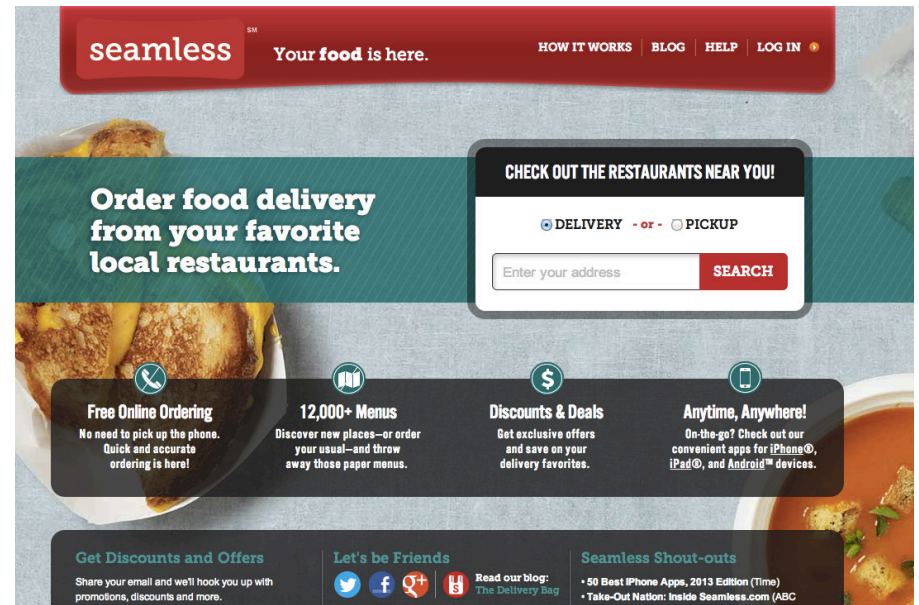

↑ Order Lunch!



# PRO TIP

Take the most important thing on the page, make it the biggest.



**“Don’t make  
me think!”**

- Steve Krug in a book by that name.



# NOT THINKING

OK. This looks like the product categories...



Memory, Modems... There it is: Monitors. **Click**



The screenshot shows the ACME website homepage. At the top, there's a navigation bar with "GET IT NOW ACME" and "free shipping on all PC software & accessories". Below that, there are links for "Build and Buy a Gateway PC", "Talk to Us", and "Store Directory". The main content area is divided into several sections: "Need Help?" with a search bar, "Today's Get it Now Deal" featuring an Intel PC Camera Pack, "Today's Best Buys" with various hardware items like a scanner and a camera, "Today's Software Special" for InculcateIT software, and a "Back to School" section. On the right side, there are promotional banners for "Enter to Win!", "Gateway Profile", "Spot Light", and "Build Your PC Today". A footer at the bottom contains copyright information: "All contents and software Copyright © 1999-98, MED Direct, LLC. All Rights Reserved."

...and these are today's special deals.



# THINKING

Hmm. Pretty busy. Where should I start?



Hmm. Why did they call it that?



Can I click on that?



Is that the navigation? Or is *that* it over there?



Why did they put that *there*?



Those two links seem like they're the same thing. Are they really?





The answer to the question

**“What is this?”**

should be

**100%**

immediately and

blindingly

**OBVIOUS**



# **ORIENTATION**

Where am I? (Don't let 'em get lost)



# How did I get here?

Give people a safety net.

# Where can I go now?

Don't leave them at a dead end



← give me a clue to where I am

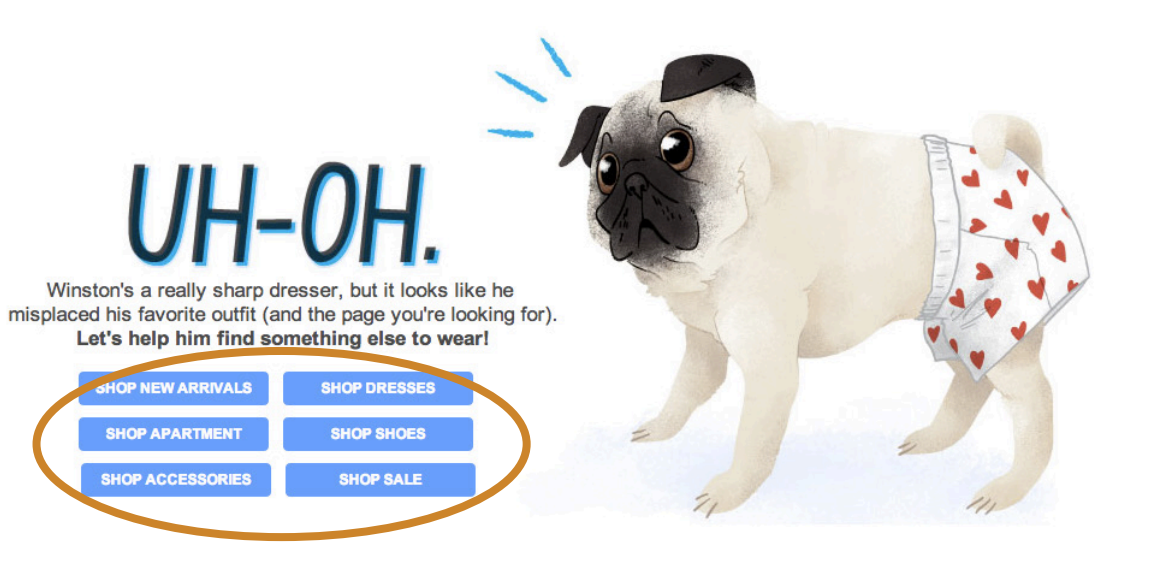

← anticipate where I want to go

## Dynamic Text Breadcrumbs

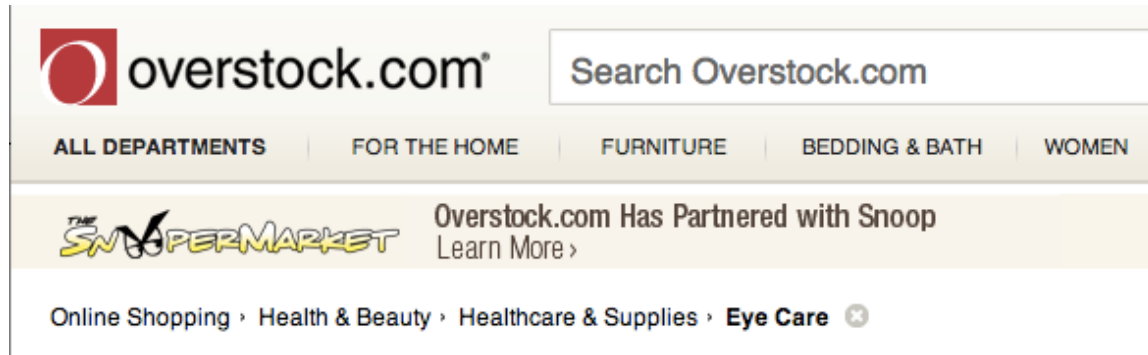
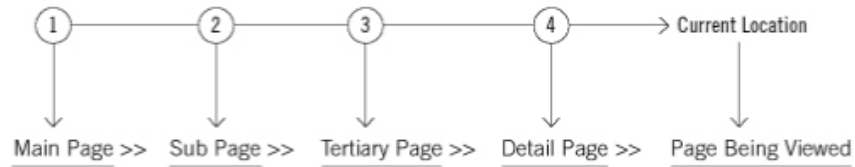

← show me how I got here

## Graphical Breadcrumbs



## theguardian

News | US | World | Sports | Comment | Culture | Business | Money | Enviro

News > Science > Medical research > Infectious disease | Cancer | Drugs

### Prescriber Checkup

The Doctors and Drugs in Medicare Part D

[Prescriber Checkup](#) » Search for markk smithh

**0 results match your search.**

#### Search for a Prescriber

State: All States **SEARCH**

For example: Mark Smith, Tufts University

[Tweet](#) 380 [Like](#) 13

**Related Story: Medicare Drug Program Fails to Monitor Prescribers, Putting Seniors and Disabled at Risk »**

#### What's Not Here

To be included, a provider had to write 50 or more prescriptions for at least one drug in Medicare Part D in 2010. Medications provided at an office visit or hospital aren't included because they are covered by other parts of Medicare. Prescriptions also are not included for Medicare enrollees covered through employers, the Veterans Health Administration or some retiree health plans.

PREVIOUS STORY: Fans honor Walter White with ad in local Albuquerque newspaper

NEXT STORY: Influential Apple designer calls Steve Jobs biography 'disappointing'

**Web** Images Maps Shopping More Search tools

About 578 results (0.24 seconds)

Did you mean: [how do I make a turducken](#)

← give me an explanation and a way out

← lead me to cool places

← correct my silly mistakes



and most of all

# show me the way home

↓



POPULAR SCIENCE THE FUTURE NOW

Login/Register | Newsletter | Subscribe

GADGETS CARS SCIENCE

GALLERIES VIDEOS COLUMNS

## Google Street View Can Help Scientists Monitor Invasive Species

Field work from home

By Shaunacy Ferro Posted 10.21.2013 at 1:00 pm

f t d+ g+ + 1

↓



The New York Times Business Day

## Energy & Environment

WORLD U.S. N.Y. / REGION BUSINESS TECHNOLOGY SCIENCE HEALTH SPORTS OPI

Search International DealBook Markets Economy Energy M

## An Odd Alliance in Patagonia



↓

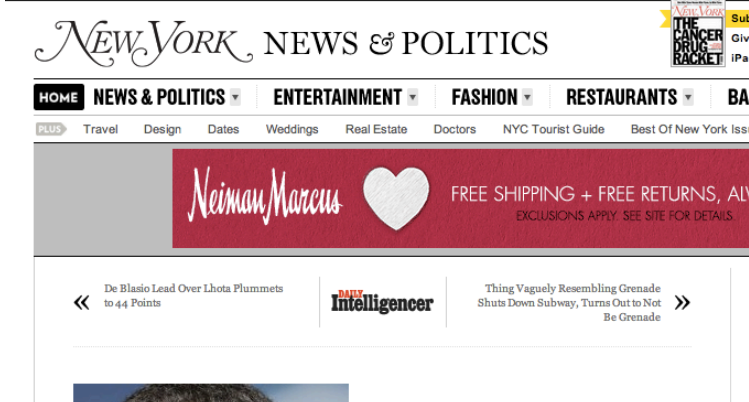

NEW YORK NEWS & POLITICS

HOME NEWS & POLITICS ENTERTAINMENT FASHION RESTAURANTS BA

PLUS Travel Design Dates Weddings Real Estate Doctors NYC Tourist Guide Best Of New York Issu

Neiman Marcus FREE SHIPPING + FREE RETURNS, ALL EXCLUSIONS APPLY. SEE SITE FOR DETAILS.

De Blasio Lead Over Lhota Plummetts to 44 Points

DAILY Intelligencer

Thing Vaguely Resembling Grenade Shuts Down Subway, Turns Out to Not Be Grenade

↓

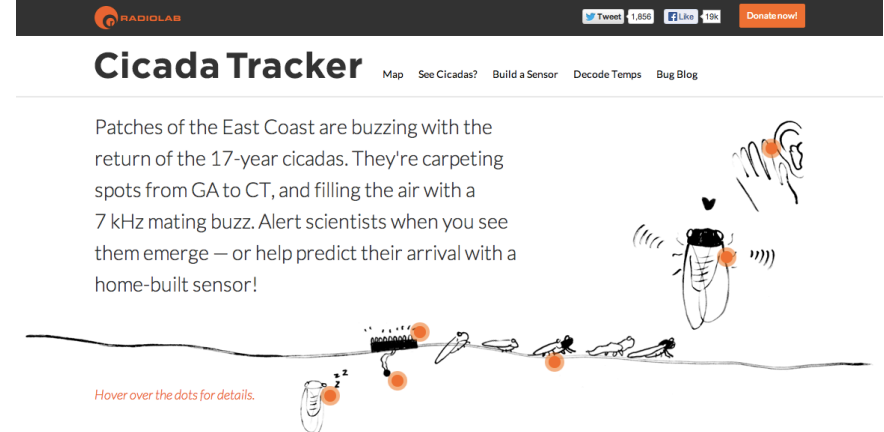

RADIOLAB

Tweet 1,856 Like 19K Donate now!

## Cicada Tracker

Map See Cicadas? Build a Sensor Decode Temps Bug Blog

Patches of the East Coast are buzzing with the return of the 17-year cicadas. They're carpeting spots from GA to CT, and filling the air with a 7 kHz mating buzz. Alert scientists when you see them emerge – or help predict their arrival with a home-built sensor!

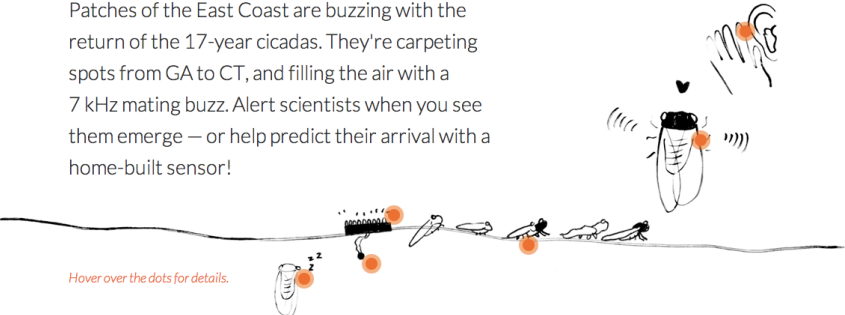

Hover over the dots for details.

3

# **INTUITION**

What do I do here? No instruction manual, please



**THX FOR THE PULLING HANDLES  
AND YOUR INSTRUCTIONS TO BE PUSHING THEM**

# Conceptual Model



A good conceptual model allows us to predict the effects of our actions.



A bad conceptual model has no discernible relationship between my actions and the end result.

# Affordances



A wheel affords rolling



A light switch affords flipping

# Mapping



Which knob turns on the middle bottom burner?  
Well, um..



I got this.

# Constraints

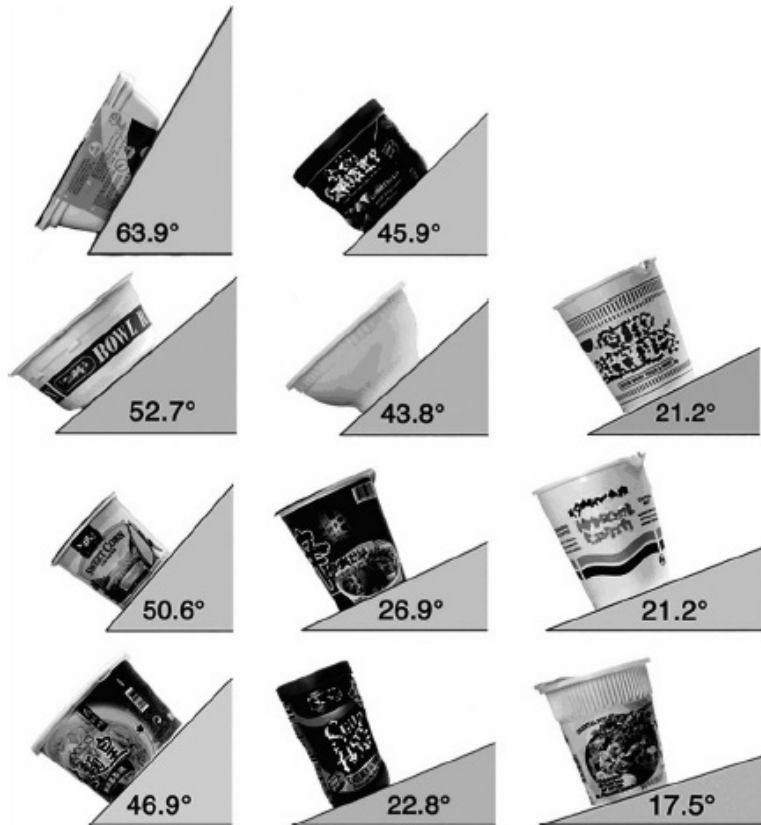

Figure 1. Representative pictures of the shapes of the soup containers and the angle that was required for the container to “tip over” on to its side.



Narrow containers = painful soup burns.  
Why do they still exist?

0% sliced fingers: only works  
when it's closed. GENIUS.

**but what about**  
**COMPUTERS?!**

and laptops  
and iPhones and tablets  
and  
any and all kinds of  
new fangled screens?!?







No natural mapping

No affordances  
(I can click all the things)

No obvious conceptual model



# PRO TIP

Take advantage of conventions

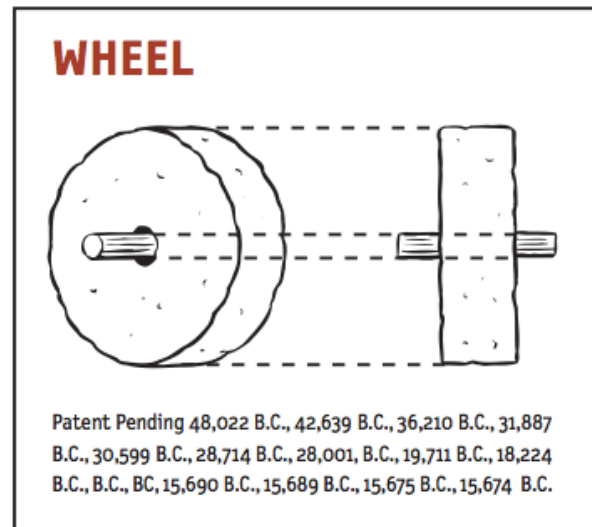

# Seeing the Kliuchevskoi Eruption From Land and Space

← headlines

BY ERIK KLEMETTI 10.21.13 11:06 AM ← bylines, date

 Follow @eruptionsblog

buttons that look like buttons



Search  X 

↑  
search fields

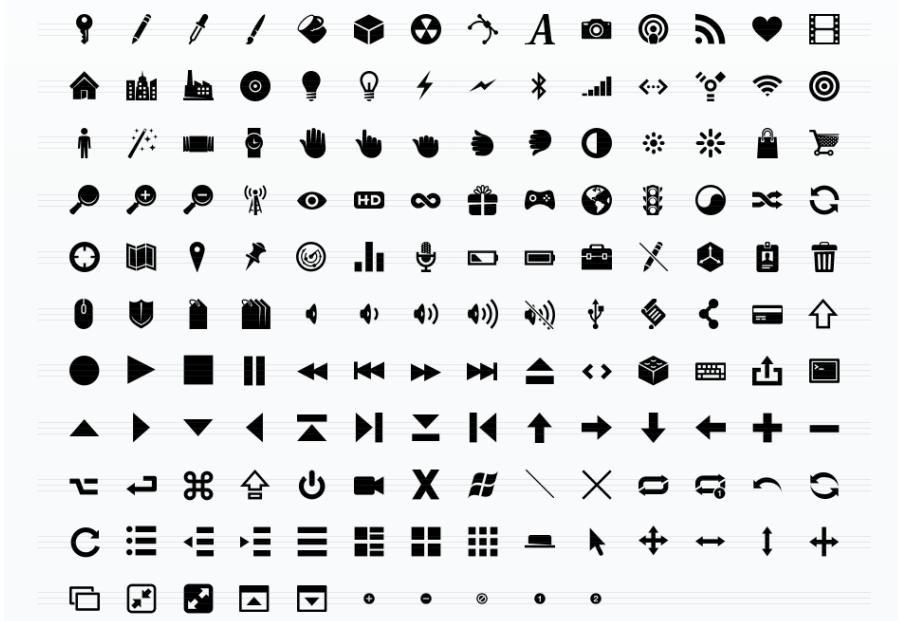

←  
standard icons

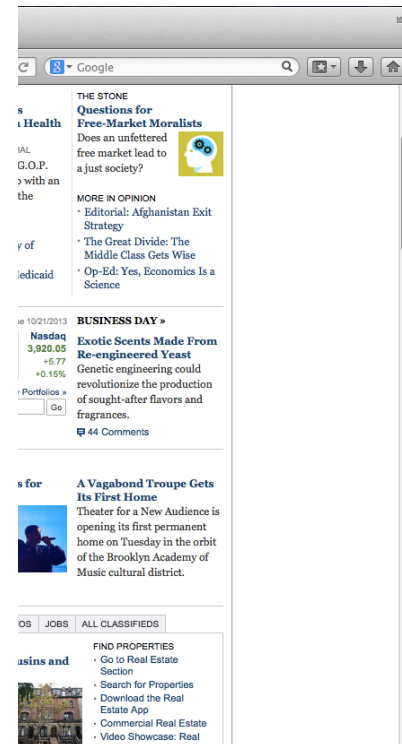

←  
right scrollbars



# PRO TIP

Make it obvious what's clickable

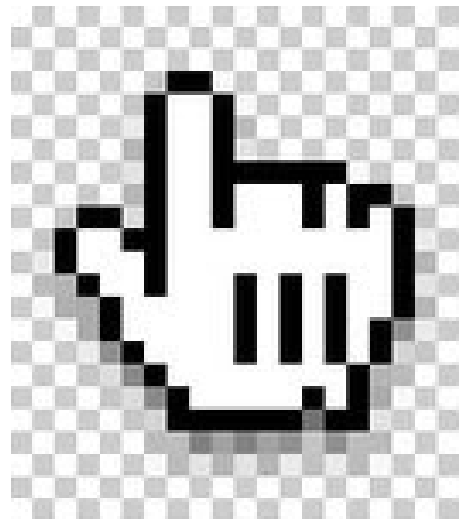

< OBVIOUSLY CLICKABLE

REQUIRES THOUGHT >

Click



Results

Hmm.  
*[Milliseconds of thought]*  
I guess that's a button.  
Click



Results

Hmm.  
Is that a button?



▶ Results

buttons that look like buttons



blue and/or underlined text



off sooner. Scientists have used balloons, small rockets, and even gliders to study the region. The nascent commercial space companies like World View could offer more opportunities for scientists at a lower cost.

whether to become need-aware, it would remain need-blind for the time being -- but would still look to wealthier students in the recruitment process and use merit aid to

# If it can't be **TOTALLY** obvious give hints!

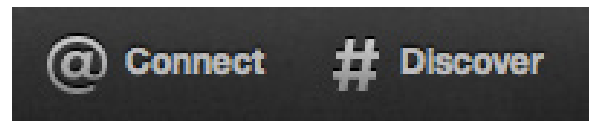
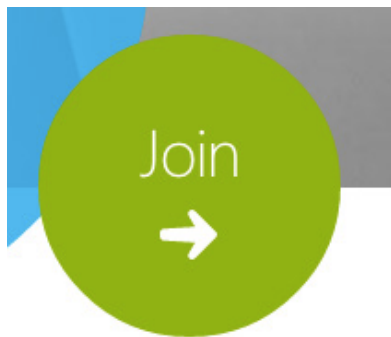

arrows

rounded corners

colored background

contrast

icons

Part 3: Joint Replacement ▾

 JOIN THE DISCUSSION

 ADD A COMMENT

 FACEBOOK

 TWITTER



1 of 3



# (CSS can help)

```
a:hover {  
  color:black;  
}
```

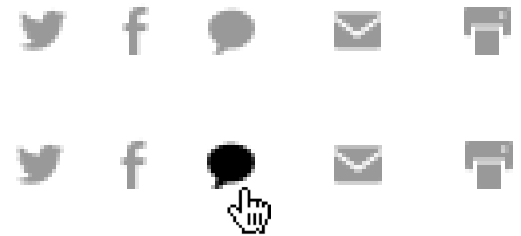

```
span {  
  cursor: pointer;  
}
```

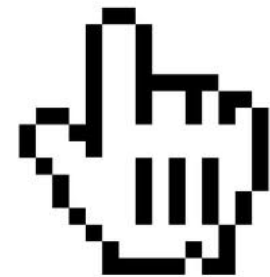





# PRO TIP

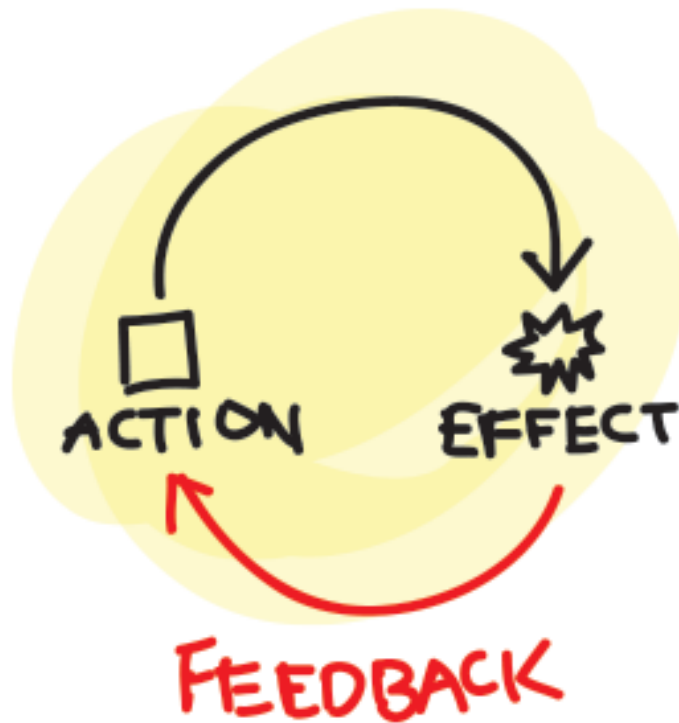

Give feedback  
(tell me what I just did)



← hovers

You have been signed out. Sign in to see your stuff.

[Sign in](#)

Don't have a personalized Google homepage? [Get started.](#)

← confirmation



← spinning wheels of doom



# PRO TIP

Simplify, simplify, simplify.

~~Darlings~~



**good  
luck!**